

PSR0801

 | Shaft dia. $\phi 8$ Lead 1mm

C5

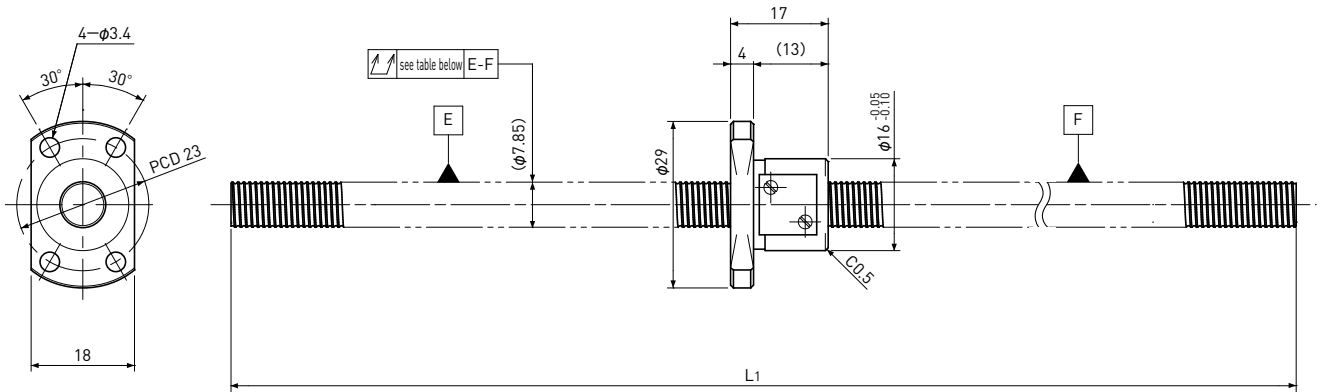

Unit: mm

Ball Screw Specifications		
Ball size	$\phi 0.8$	
Number of thread	1	
Thread direction	Right	
Shaft root dia.	$\phi 7.3$	
Number of circuit	3.7×1	
Material	Shaft	S55C
	Nut	SCM415H
Surface hardness	HRC58~ (Thread area)	
Anti-rust treatment	Anti-rust oil	

Unit: mm

Ball Screw Model	Travel	Shaft length	Travel deviation e_p	Total Run-out 	Axial play	Basic Load Rating N	
		L_1				Dynamic C_a	Static C_oa
PSR0801-230R230C5	205	230	± 0.023	0.065	~ 0.005	780	1650

Note) Please designate end-journal profile with your sketch.